

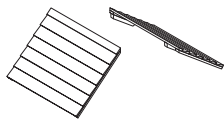









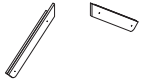
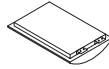

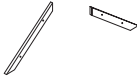

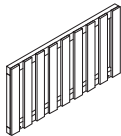



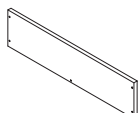

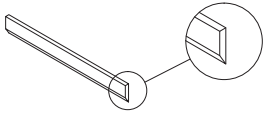

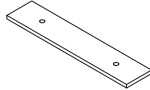

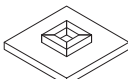
1		1PC	6		2PCS
			7		2PCS
2		1PC	8		2PCS
			9		4PCS
3		2PCS	10		1PC
4		1PC	11		1PC
5		1PC	12		2PCS

13		2PCS	27		1PC
14		2PCS	28		1PC
15		1PC	29		2PCS
16		1PC			
17		1PC	A	 Φ6*90mm	2PCS
18		4PCS	B	 Φ3.5*50mm	65PCS
19		2PCS	C	 Φ3.5*35mm	36PCS
20		2PCS	D	 Φ3*35mm	42PCS
21		2PCS	E	 Φ3*25mm	14PCS
22		1PC	F	 Φ3*16mm	4PCS
23		1PC	G	 Φ4*30mm	2PCS
24		2PCS	H		1PC
25		1PC	I	 Φ4*40mm	4PCS
26		1PC	1		

2

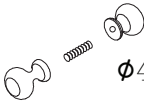

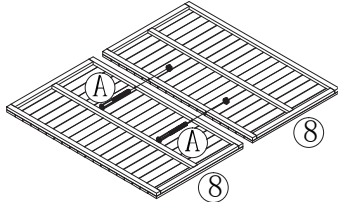
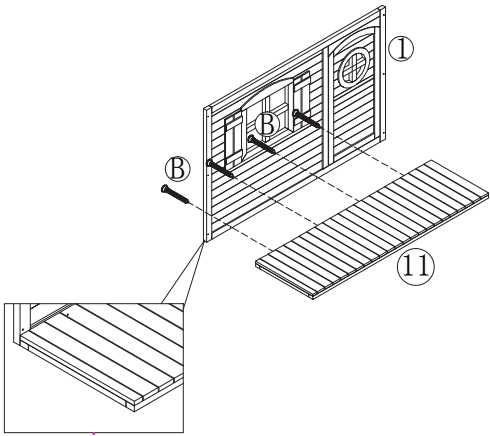
3

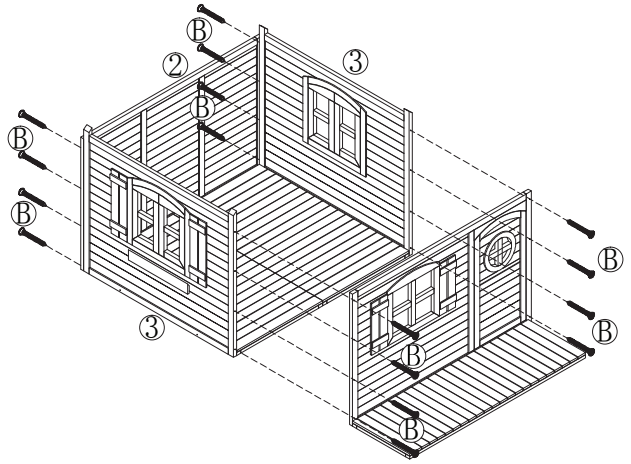

4

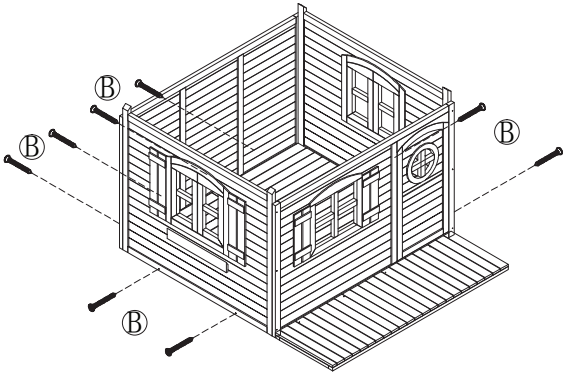

5

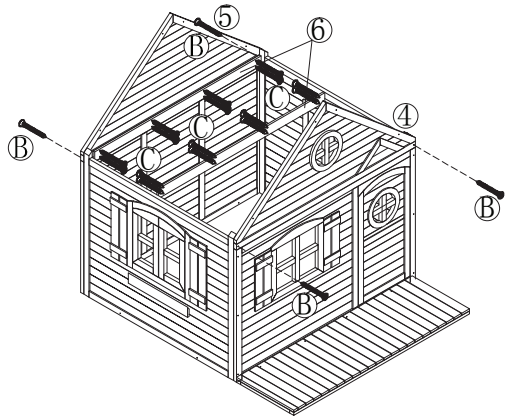

6

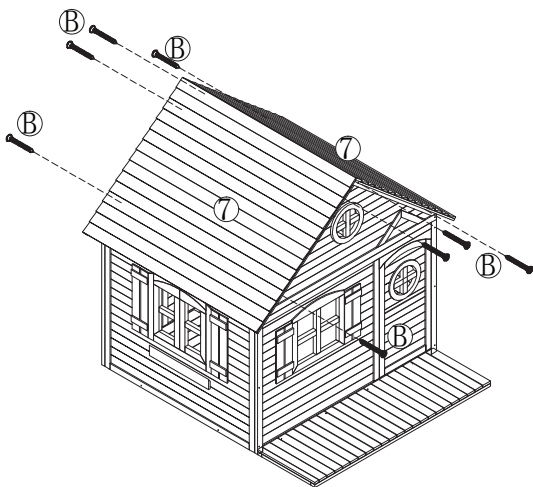

7

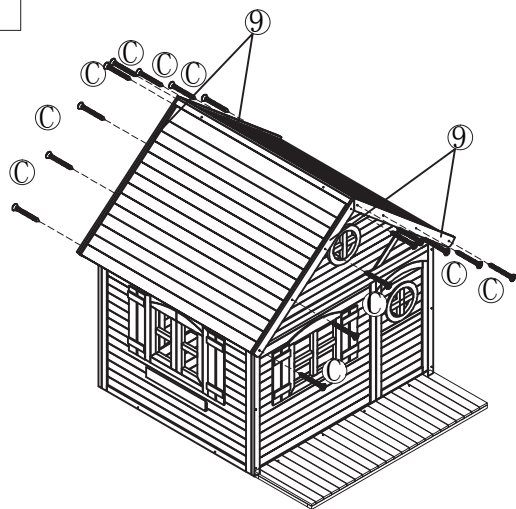

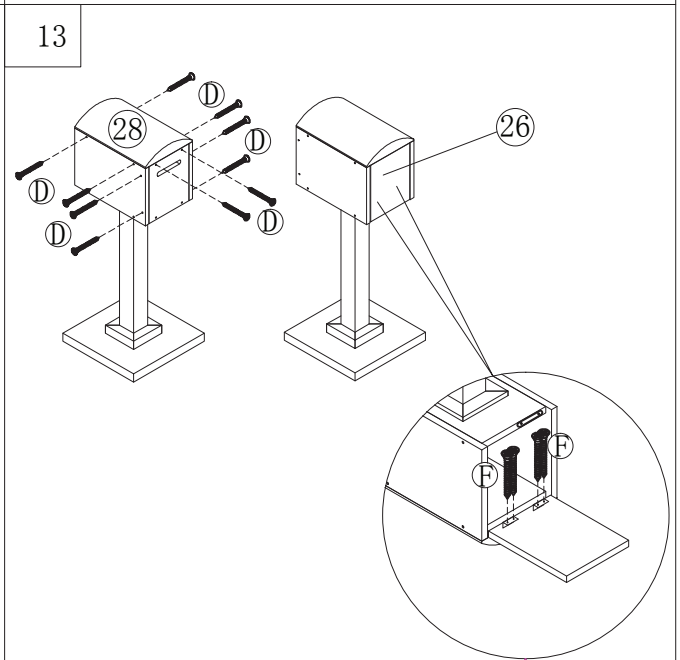
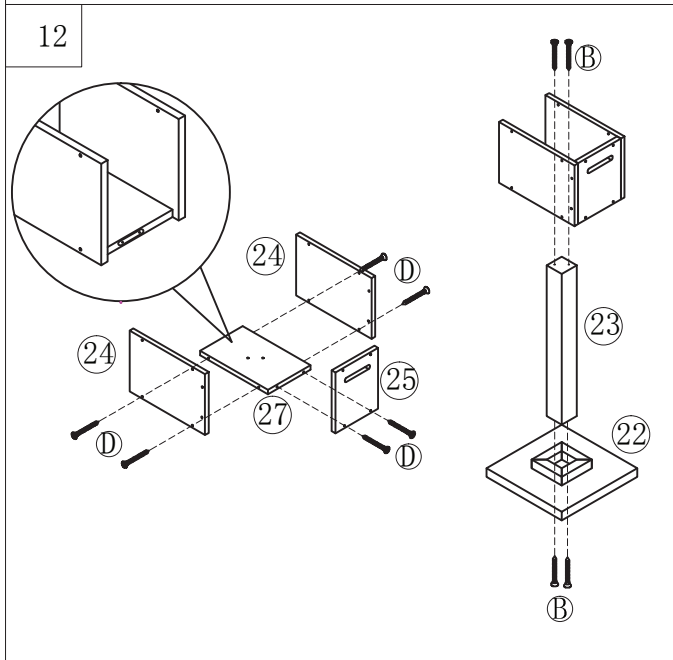
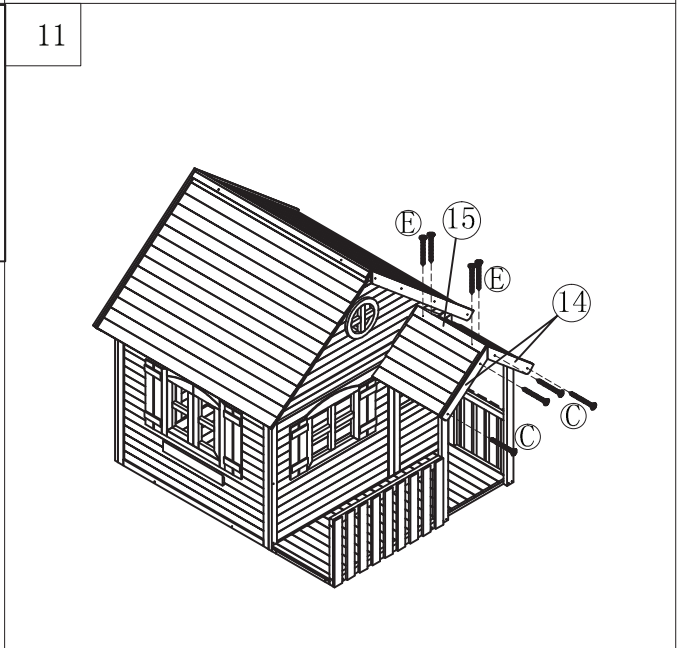
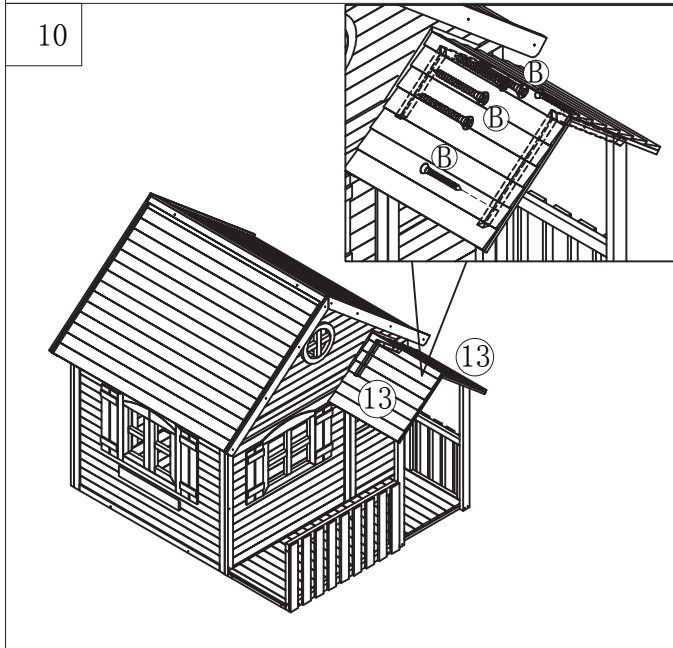
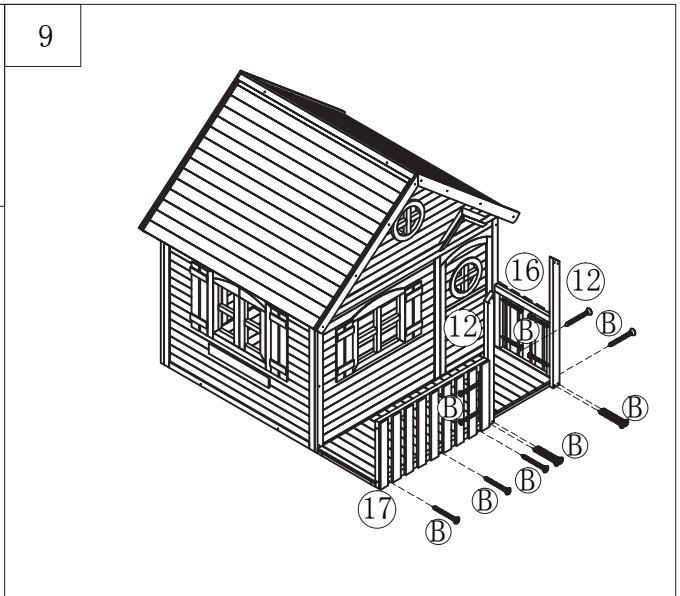
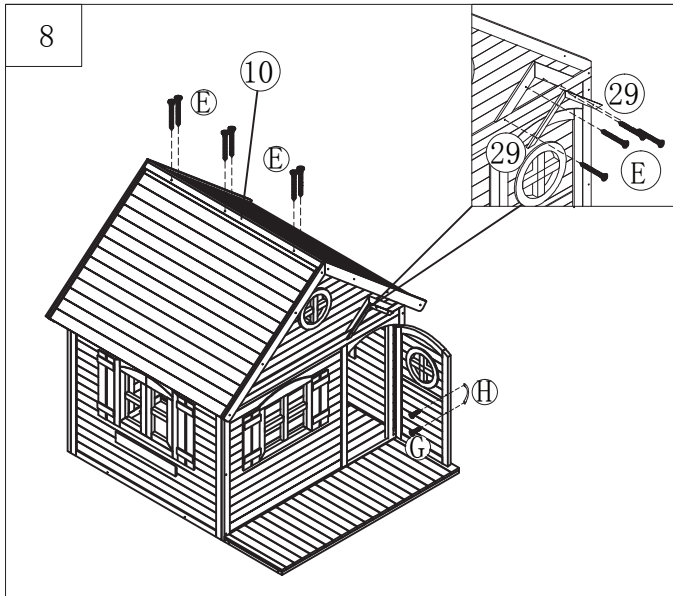

14

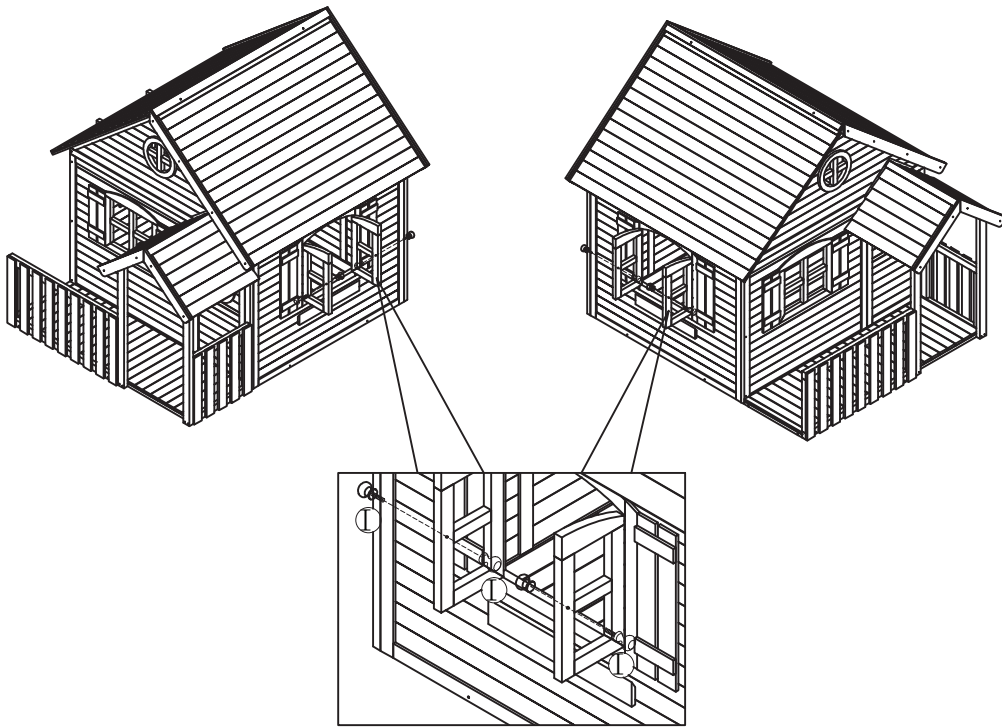

15

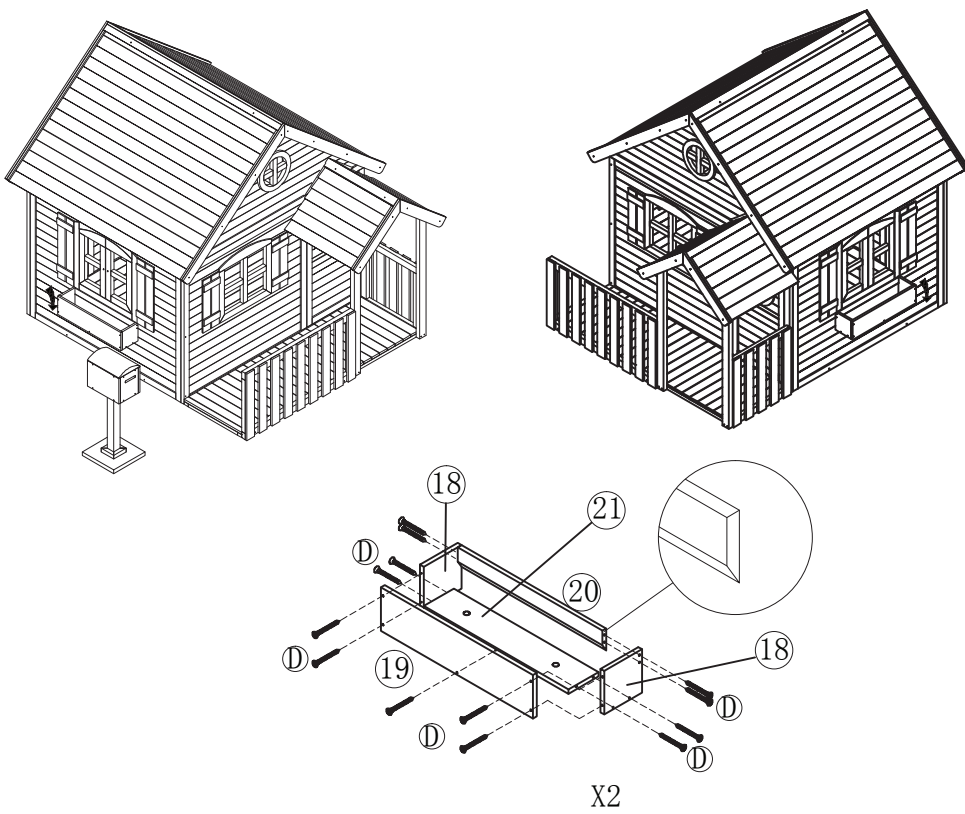

NO:5-5